

HYUNDAI
POWER PRODUCTS

GASOLINE MULTI TOOL KIT HCOMBI55-1

ORIGINAL INSTRUCTIONS

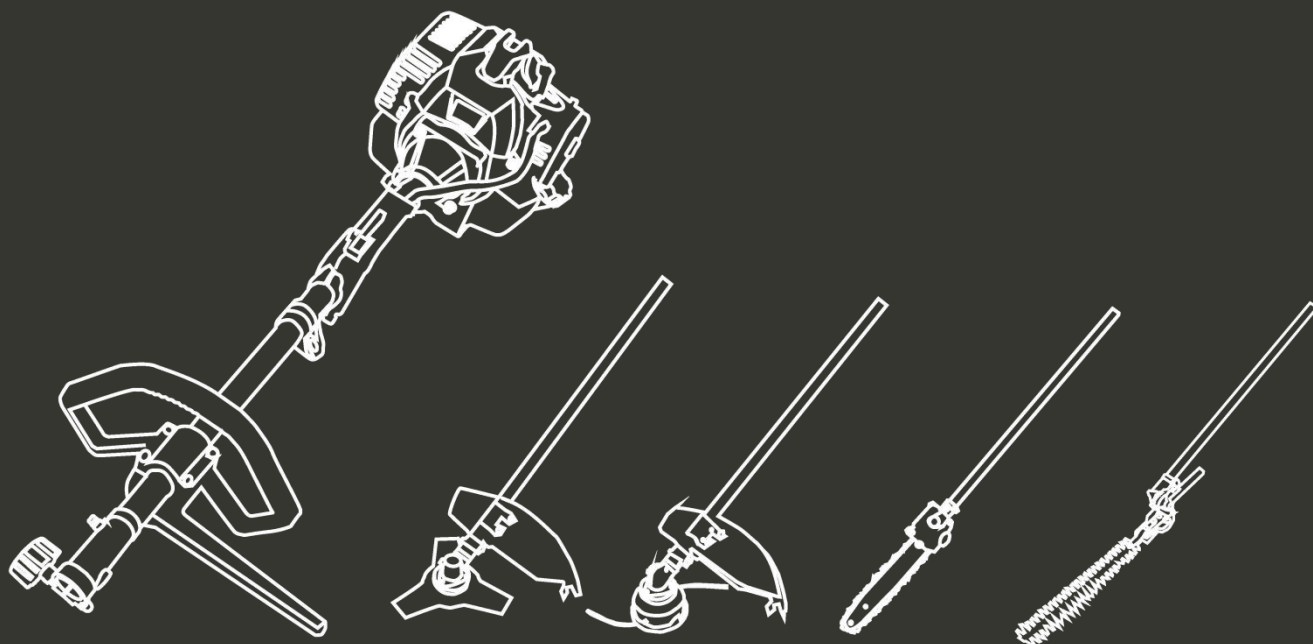

WARNING: Read thoroughly the instruction manual before use!

CONTENTS

1. SAFETY INSTRUCTIONS	3
2. THE TOOL	12
3. ASSEMBLY	18
4. FILLING THE FUEL TANK	22
5. OPERATION	23
6. CARE AND MAINTENANCE	25
7. TECHNICAL DATA	28
8. TROUBLESHOOTING	30
9. EC DECLARATION OF CONFORMITY	31
10. WARRANTY	32
11. PRODUCT FAILURE	33
12. WARRANTY EXCLUSIONS	34

1. SAFETY INSTRUCTIONS

1.1 BRUSH CUTTER AND GRASS TRIMMER

- **WARNING!** When using this type of tool, basic precautions should always be followed to reduce the risk of fire and injury.
- Read all instructions carefully before attempting to use this product and retain these instructions. Be familiar with all the operations described in these operating instructions. This product must be operated by experienced users.
- Inexperienced users shall first have training in all operations with a professional.
- If you are giving this machine to others, please also provide them with this instructions manual.
- Read all markings affixed on the product (symbols, stickers, technical data, etc.). The symbols are explained in this manual.
- Use this machine as described in this instruction manual. It is strictly forbidden to use this tool for applications other than those described in this manual.
- Failure to follow these instructions can result serious injuries and, in some cases, death.
- This product is intended for private domestic use only. Do not use it for commercial purposes.
- Never let people unfamiliar with these instructions or children use this product.
- National regulations may limit the use of the machine.
- People under the age of 18 must not use this product
- Keep in mind that the operator or user is responsible for accidents or risks to other persons or their property.
- **WARNING:** Do not use of the unit when tired, ill or under the influence of alcohol or other drugs.
- Do not use the tool if you are not in an adequate physical condition.
- This tool is intended for outdoor use. Never use it indoors.
Secure the machine during transport to prevent loss of fuel, damage or injury; always install the protection device on the blade, check the cap of the fuel tank, and do not transport the tool upside down. Keep people and animals away from the work area. Children and people who do not know how to use this tool should not touch it and handle it.
- **WARNING:** Keep people at least 15 m from the machine during operation.
- Use the product only under daylight or under good artificial light.
- When using the machine, always wear full protective equipment including a protective helmet, protective mask, hearing protection, ocular protection, gloves, slip-resistant foot protection and protective clothing. The protective equipment shall be in conformity with the European norms.
- Wear appropriate clothing. Do not wear loose or unbuttoned clothes. Do not wear jewellery that may come in contact with moving parts. If you have long hair, tie them down and wear an appropriate safety helmet.
- Do not operate the product with damaged guards or shields not in place.
- Keep hands and feet far away from the cutting parts at all times and especially when switching ON/OFF the tool.
- Do not use the tool in an area where ventilation is poor. Gas emissions can cause injury.
- Do not work when it rains and in bad weather. Do not use the tool in damp locations.
- Do not use the tool in the presence of flammable liquids or gases.
- Keep the work area clear. Before working, inspect the work area and remove any materials or objects that could cause accidents.
- Do not force the tool.
- Use only accessories and guards supplied or recommended by the manufacturer. The use of non-recommended accessories (e.g. metal multi-piece pivoting chains and flail blades) may result an accident. Ask your dealer for advice.
- Keep firm footing and balance during operation. Always use the harness provided.
- Have a correct working posture; stay stand, do not lean. The working positions should be changed regularly.
- Always inspect the machine before and after operation. If the tool is damaged or faulty, stop using the tool and bring it to an authorized service for inspection and repair.
- Be concentrated when using the tool. Look at what you do, make sense and do not use the tool when you are tired.
- Remove the blade guard before using the tool.

- A damaged part must be properly repaired or replaced by an authorized service center, unless otherwise specified in this instruction manual.
- Do not use the tool if the switch is not working (if it cannot be turned ON or OFF).
- Immediately stop the tool in the event of a malfunction of the motor or in case of unusual noise.
- Do not use the tool if the starter is damaged.
- Avoid any contact with the cutting attachment during operation; they can cause severe cuts.
- When not in use, the machine must be stored in a dry, locked place out of the reach of children.
- Before using the tool and after any impact, please check for signs of wear or if it is not damaged. If repairs are required, they should be done by a qualified service.
- Always switch off the machine:
 - Every time you leave it unattended;
 - Before inspection and maintenance
 - after hitting a foreign object;
 - When abnormal vibration occurs;
 - During the replacement of parts.
- Do not use the product on a slippery surface.
- Do not use the product on steep, slippery slopes.
- When planning your work schedule, allow enough time for rest. Limit continuous use of the tool. For example, do 30 ~ 40 minute sessions interspersed with a 10 ~ 20 minute break. Work a maximum of two hours a day.
- If the machine has struck foreign objects, check if the tool is damaged and bring it to repair if necessary.
- Keep handles dry, clean and free of oil and grease. Oily, greasy grips are slippery and cause loss of control.
- Be careful when using the machine during stormy weather. Do not use the machine during lightning and thunderstorms.
- Warning - When operating the tool, be careful of the emission of exhaust gases, avoid to be exposed to these and wear protective equipment.
- For machines with a clutch, check regularly that the cutting attachment stops turning when the engine idles.
- Check the tool before and after use. Check for loose fasteners, fuel leaks and damaged parts, such as cracks in the cutting attachment. If the tool is damaged, if parts are missed or meet some dysfunctions, do not use the tool and bring it to a service agent for inspection and reparation. Check the tool after dropping or other impacts to identify any significant defects; if any defects are observed, stop to use the tool and bring it to a service agent for inspection and reparation.
- Do not store in a closed area where fuel vapors can reach an open flame from hot water heaters, furnaces, etc. Store in a locked, well-ventilated area only.
- Never place the machine in any places where there are flammable materials (dry grass, etc.), combustible gasses or combustible liquids.
- When the machine is placed in storage for a long time, drain fuel from the fuel tank and carburettor, clean the parts, move the machine to a safe place and confirm that the engine is cooled down.

Fuel Handling

- Be very careful when handling fuels. They are flammable and the vapors are explosive.
- Use only an approved container.
- Never remove the fuel cap or add fuel while the machine is on. Turn off the unit and allow the engine and exhaust components to cool before refuelling.
- Do not smoke.
- Never refuel inside a room.
- Never store the tool and the fuel tray indoors where there is a naked flame, such as near a water heater.
- If fuel has spilled, do not attempt to start the machine, but rather move it away from the spill before starting to use it. Clean any spills.
- Replace and tighten the fuel tank cap after refueling.
- Follow the instructions in this manual for filling the tool with fuel.

Maintenance and storage

- Stop the tool and wait until it stops. Make sure all moving parts have come to a standstill.
- Allow the machine to cool before performing inspection, adjustments, maintenance, servicing and

storage.

- Maintenance and cleaning shall always be done after operation. Follow the instructions given in this manual for maintenance, cleaning and storage.
- Store the tool where fuel vapors will not reach a flame or spark.
- During transport, maintenance and storage, always install the cover on the metal blade.

Kickback and related warnings

Kickback is a sudden reaction to a pinched or snagged rotating wheel, backing pad, brush or any other accessory. Pinching or snagging causes rapid stalling of the rotating accessory which in turn causes the uncontrolled power tool to be forced in the direction opposite of the accessory's rotation at the point of the binding.

For example, if a cutting attachment is snagged or pinched by the workpiece, the edge of the wheel that is entering into the pinch point can dig into the surface of the material causing the wheel to climb out or kick out. The wheel may either jump toward or away from the operator, depending on direction of the wheel's movement at the point of pinching. Abrasive wheels may also break under these conditions.

Kickback is the result of power tool misuse and/or incorrect operating procedures or conditions and can be avoided by taking proper precautions as given below:

- Never place your hand near the rotating accessory. Accessory may kickback over your hand.
- Do not position your body in the area where power tool will move if kickback occurs. Kickback will propel the tool in direction opposite to the wheel's movement at the point of snagging.
- Use special care when working corners, sharp edges etc. Avoid bouncing and snagging the accessory. Corners, sharp edges or bouncing have a tendency to snag the rotating accessory and cause loss of control or kickback.

Residual risks

Even if you use this product in accordance with all safety requirements, the potential risk of injury and damage remains. The following hazards may arise:

- There are harmful health consequences resulting from the emission of vibrations if the product is used for long periods of time or not managed adequately and properly maintained. The vibrations can produce the so-called "white finger" disease. If any of the symptoms of "white finger" syndrome appear, see a doctor immediately. Symptoms of the "white finger" include: numbness, loss of sensitivity, tickling, tingling, pain, loss of strength, colour changes, or skin condition. These symptoms usually appear on the fingers, hands or wrists. The risk increases at low temperatures. To reduce this risk, please wear gloves and keep your hands warm. Limit the operating time.
- There is a risk of hearing loss during prolonged use, in particular if you do not wear hearing protection. Always wear hearing protection and limit the operating time.
- Cuts if no suitable protective clothing is worn.
- Inhalation of particles and exhaust gases if a mask of protection is not worn.
- Contact with projected objects.
- Burns when touching with hot surfaces.

Intended use

This machine can be used as a trimmer with the cutting edge, and as a brushcutter with the cutting blade. The grass trimmer must be strictly and only to cut grass or weeds that are not too dense. The brush cutter must be used to cut hard grass, more dense weeds and small branches with a maximum diameter of 10mm.

This machine is not intended to cut bushes or others similar plants requiring the tool to get off the ground. Do not use this tool to work other materials such as stones, clay soils, etc.

1.2 HEDGE TRIMMER

IMPORTANT

Read carefully before use Keep for future reference

Safe operating practices

Training

Become familiar with the owner's manual before attempting to operate the equipment.

Preparation

- a) THIS HEDGE TRIMMER CAN CAUSE SERIOUS INJURIES. Read the instructions carefully for the correct handling, preparation, maintenance, starting and stopping of the hedge trimmer. Become

- familiar with all controls and the proper use of the hedge trimmer.
- b) Never allow children to use the hedge trimmer.
 - c) Beware of overhead power lines.
 - d) Avoid operating while people, especially children, are nearby.
 - e) Dress properly! Do not wear loose clothing or jewellery, which can be caught in moving parts. Use of sturdy gloves, non-skid footwear and safety glasses is recommended.
 - f) Use extra care when handling fuels. They are flammable and the vapors are explosive. The following points should be observed:
 - Use only an approved container.
 - Never remove the fuel cap or add fuel with the power source running. Allow engine and exhaust components to cool down before refueling.
 - Do not smoke.
 - Never refuel indoors.
 - Never store the hedge trimmer or fuel container inside where there is an open flame, such as near a water heater.
 - If fuel is spilled, do not attempt to start the power source, but move the hedge trimmer away from the spillage before starting.
 - Always replace and securely tighten the fuel cap after refueling.
 - If the fuel tank is drained, this should be done outdoors.
 - g) If the cutting mechanism strikes any foreign object or the hedge trimmer starts making any unusual noise or vibration, shut off the power source and allow the hedge trimmer to stop. Disconnect the spark plug and take the following steps:
 - inspect for damage;
 - check for, and tighten, any loose parts;
 - have any damaged parts replaced or repaired with parts having equivalent specifications
 - h) Wear ear protection.
 - i) Wear eye protection.
 - j) In case of emergency, stop the hedge trimmer; release the trigger, switch off the tool with the ON/OFF button. Let it completely stop and be cool before any intervention.

Operation

Use the tool for the intended purpose and follow these provided instructions for use and maintenance

- a) Stop the engine before:
 - cleaning or when clearing a blockage,
 - checking, carrying out maintenance or working on the hedge trimmer,
 - adjusting the working position of the cutting device,
 - Leaving the hedge trimmer unattended.
- b) Ensure that the hedge trimmer is correctly located in a designated working position before starting the engine.
- c) While operating the hedge trimmer, always ensure that the operating position is safe and secure, especially when using steps or a ladder.
- d) Do not operate the hedge trimmer with a damaged or excessively worn cutting device.
- e) To reduce fire hazards, keep the engine and silencer free of debris, leaves and excessive lubricant.
- f) Always ensure that all handles and guards are fitted when using the hedge trimmer. Never attempt to use an incomplete hedge trimmer or one fitted with an unauthorized modification.
- g) Always use two hands to operate a hedge trimmer fitted with two handles.

Maintenance and storage

- a) When the hedge trimmer is stopped for servicing, inspection or storage, shut off the power source, disconnect the spark plug wire from the spark plug and make sure all moving parts have come to a stop. Allow the hedge trimmer to cool before making any inspections, adjustments, etc.
- b) Store the hedge trimmer where the fuel vapour will not reach an open flame or spark. Always allow the hedge trimmer to cool down before storing.
- c) When transporting or storing the hedge trimmer, always fit the cutting device transport guard.

Additional instructions

- Never allow children to use the hedge trimmer.
- Work only during in the day or with a sufficient artificial light.
- Before starting to work, check the condition of the tool.
- Ensure that all the parts of the machine are well fixed and tightened.
- Control regularly that the blade of cut is in good state.
- Always hold firmly the hedge trimmer with the two hands.
- Never take or hold the hedge trimmer by the blade.
- Maintain clothing out of reach blade as well with the stop as under operation.
- Keep the device distant from all shapes of sparks, flames and flammable materials.
- Control that the working areas are free from all shapes of obstacles.
- Work with precaution, be not distracted.
- Do not use the tool when you are under the influence of alcohol, meds or drugs, and where you are sick.
- Dry all possible gasoline traces by using a dry rag.
- In case of accident, immediately stop using the machine. Check the problem. Do not use the machine while the machine is damaged.
- Operate the machine only at reasonable hours – not early in the morning or late at night when people might be disturbed;
- When blockage occurs, immediately turn off the engine with the ON/OFF button. Let the tool cool down. Check and correct the blockage before starting again to work. Use gloves when clearing a blockage. Restart the machine securely when the machine is totally unblocked.
- When a danger or a non-intended situation arise, stop to work immediately and switch off the tool. Restart to work when there is no danger and you are able to work safely.
- Cut before the large branches with a hand shears to avoid the blocking of the blade.
- Pay attention not to cut iron wire or others.
- Do not use non-recommended accessories with this tool. To replace any piece of this tool, please contact the retailer, service agent or manufacturer.
- Use only the mixture recommended by the manufacturer.
- Store the mixture in a specific container for the gasoline.
- Keep the device in a quite dry place and out of reach of children.
- Store the mixture only on free air or in a well-ventilated place. Handle the fuel with precaution, it is highly flammable.
- Do not smoke or use telephone when you handle gasoline.
- Use a funnel and fill the tank only when the engine is cold.
- Do not open the tank if the engine is hot or under operation.
- Keep [people and yourself far away from the exhaust to avoid the risks of burns.
- Maintain the people and the animals far away from the working area.
- Always remind that this machine can cause very serious incidents.
- Do not work under the rain and/or in places wet and/or slipping.
- Do not expose to the rain.
- Do not use the tool during bad weather conditions and where a risk of lighting is possible.
- Use complete personal protective equipment during the use of the tool: gloves, antiskid footwear, helmet, eyes protection, protection clothes, and mask of protection.
- Do not use the machine when you are tired, under the influence of alcohol or drugs or sick.
- The machinery must not be used in a way where experience has shown that danger and/or risks might occur.
- The ignition and the carburettor must not be set by the user. This procedure shall be done by our service agent.
- Never use hedge trimmer inside a building. Your hedge trimmer produces toxic exhaust fumes as soon as the engine is started. The use of this product can generate dust, vapors and smoke containing chemicals known for their harmful effects on health. So be careful during the use of your machine and protect yourself correctly. Also avoid voluntarily breathing exhaust fumes; always hold the machine correctly when you use it.

Residual risks

Even if you use this product in compliance with all safety requirements, the potential risks of injury and damage remain. The following hazards may arise in the structure and design of this product. Always be vigilant when using this product, so you can recognize and manage the risks rather. Rapid intervention can prevent serious injury and property damage.

- There are harmful health consequences resulting from the emission of vibrations if the product is used for long periods of time or not properly managed and properly maintained.
- There is risk of injury and property damage due to attachments or broken the sudden impact of hidden objects.
- Risk of injury to persons and property caused by flying objects.
- Prolonged use of this product exposes the operator to vibration and can produce so-called “white finger” disease. To reduce the risk, wear gloves and keep your hands warm. If any of the symptoms of “white finger syndrome” occur, seek immediate medical attention. Symptoms of the “white finger” include numbness, loss of sensitivity, tingling, tingling, and pain, loss of strength, colour changes or skin condition. These symptoms usually appear on the fingers, hands or wrists. Risk increases at low temperatures
- Inhalation of particles
- Inhalation of exhaust gases
- Unattended projections
- Contact with foreign objects
- Contact with the tool in operation
- Hearing loss in the absence of correct hearing protection

Intended use

Your hedge trimmer is a device used by a person to trim hedges and shrubs by working with one or more blades arranged linearly and back and forth. A potential hazard exists if the device is used for other purposes. Improper handling of the hedge trimmer increases the risk of injury from blades. Only the use of spare parts and accessories approved by the manufacturer is permitted.

1.3 MOUNTED POLE PRUNER

- Secure the machine during transport to prevent loss of fuel, damage or injury; always install the protection device on the blade, check the cap of the fuel tank, and do not transport the tool upside down.
- Always bring cleaning and maintenance before the storage of the tool. Follow the instructions given in this manual. Improper maintenance will increase of accidents, kickback of the blade and bad working results.
- Use the transport guard on the blade during transport and storage.
- Checking that the cutting attachment stops turning when the engine idles.
- Check the tool before and after use. Check for loose fasteners, fuel leaks and damaged parts, such as cracks in the saw blade. If the tool is damaged, if parts are missed or meet some dysfunctions, do not use the tool and bring it to a service agent for inspection and repair.
- Follow the instructions of the manual for guide-bar and chain adjustments. This shall be done with the engine stopped.
- National regulation can restrict the use of the machine.
- Always inspect the pruner before use and after dropping or other impacts in order to identify any significant damage or defects.
- Danger – Do not use the machine near overhead electric power lines.
- Warning – Do not the use of the machine when tired, ill or under the influence of alcohol or other drugs.
- Always be sure to maintain a steady, even posture while working. It is necessary to have rest periods and change working positions.
- Warning - Risk of danger for bystanders; they must be kept at a safe distance from the machine during its operation.
- Remove branches in sections.
- Warning - Avoid dangerous operating positions;
- There is a risk of being struck by falling branches or branches that, having hit the ground, rebound.

- Warning - there is a danger about the emission of exhaust gases. Do not inhale them do not be exposed to them.
- Keep firm footing and balance during operation. Use the harness provided.
- Do not use the tool if the switch is defective. In the event of a malfunction, do not use the tool and take it to a qualified service for repairs.
- Stop the tool before making adjustments, changing the accessories or storing the tool.
- Keep the tool out of the reach of children. People who are not familiar with the tool or who have not read these instructions should not use it. Tools are dangerous when used by untrained people.
- The tool must be regularly maintained. Regular tool maintenance reduces malfunctions and improves work efficiency.
- Check that the moving parts are working properly and that they are not jammed. Check that there are no broken or damaged parts that could impair the functioning of the tool. If the tool is damaged or faulty, do not use the tool anymore and bring it to a qualified service for repairs.
- Keep cutting tools sharp and clean. Carefully maintained tools with sharp edges are wedged less frequently and can be guided more easily.
- Never touch any part of the body of the cutting chain when the tool is operating. Before starting the tool, make sure that the cutting chain is not in contact with anything. A moment of inattention while using the tool may cause your garment or part of the body to stick to the cutting chain.
- Wear safety glasses and hearing protection. Additional protective equipment is recommended such as helmets, protective gloves, slip-resistant foot protection and safety clothes.
- Do not place yourself on the path of falling branches.
- Before felling, check where the trees or branches are going to fall. Make sure that there are no obstacles to prevent or hinder travel.
- Do not work in areas where the grass is wet and where the soil is slippery.
- Do not use this tool in a tree, on an unstable ladder or surface.
- Adopt a stable position and keep your balance constantly.
- Hold the tool firmly with both hands when the engine is running.
- When the chain is moving, it must not touch objects, materials or persons.
- Start cutting only with a chain at full speed.
- Do not attempt to insert the saw into a pre-existing notch. Always make a new notch.
- Pay attention to moving branches or other forces that could close a notch and pinch or hinder the chain.
- Do not attempt to cut a branch with a diameter greater than the cutting length of the chain saw.
- Always switch off the tool, let the chain completely stop before making any adjustments, maintenance, cleaning or repairs.
- The chain must remain sharp and taut. Regularly check the tension of the chain.
- Only use replacement parts and original accessories.
- Use only the manufacturers specified replacement guides and chains. Incorrect replacement guides and chains may cause chain breakage and / or rebound.
- Check that there are no obstacles or electrical wires hidden in the work area.
- Immediately stop the device if an abnormal level of vibration has been detected. In case of damage to the blade, it is necessary to change the complete set of blades.
- Use the device only if all protective devices are mounted. Do not use the device with faulty protective equipment. Do not modify the unit.
- Do not work with the tool when it rains, in bad weather or in a damp environment. Do not use the machine when there is a risk of thunderstorms and storms.
- Only work outdoors, under daylight or under artificial lighting.
- Always carry the appliance by its handle
- Tie long hair in a way to prevent them from coming into contact with the blades. Do not wear jewellery and loose clothing when operating the machine.
- The appliance should never be used near people, especially children and pets. Stop the operation immediately if this condition is not met. In all cases, ensure a safe area of at least 15 meters around the work area.
- The operator is responsible for accidents caused to others.
- Always take a stable working position. Make sure about your step on the slopes. Take extreme caution when working on slopes.
- Take regular breaks to reduce the risk of fatigue.

- Never leave the machine unattended.
- The device must always be used fully assembled and secured.
- Store the tool with its blade guard and out of the reach of children
- Never use an incomplete or unauthorized tool.
- Clean and maintain the tool before storage (see the chapters on this manual). Bring maintenance after each use according the instructions of this manual. Improper maintenance can reduce the life of the tool, bring bad results and wear the tool and its accessories.
- Check the tool regularly and before each use to observe any impact or damage.

Residual risks

Even if you use this product in compliance with all safety requirements, the potential risks of injury and damage remain. The following hazards may arise in the structure and design of this product:

- There are harmful health consequences resulting from the emission of vibrations if the product is used for long periods of time or not properly managed and properly maintained.
- There is risk of injury and property damage due to attachments or broken the sudden impact of hidden objects when using cutting.
- Risk of injury to persons and property caused by flying objects.
- Prolonged use of this product exposes the operator to vibration and can produce so-called "white finger" disease. To reduce the risk, wear gloves and keep your hands warm.
- If any of the symptoms of "white finger syndrome" occur, seek immediate medical attention. Symptoms of the "white finger" include numbness, loss of sensitivity, tingling, tingling, and pain, loss of strength, colour changes or skin condition.

These symptoms usually appear on the fingers, hands or wrists. Risk increases at low temperatures.





Intended use













The pole pruner is exclusively intended for pruning trees and/or cutting small wood from the ground. Any other use is considered improper and will damage the tool.



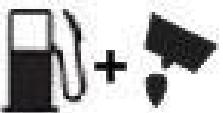

The correct use also includes reading and observing the instructions for use at each use as well as observing the warnings fixed on the machine. Before and during use, it is imperative to check the blade to ensure that there is no mechanical damage. In case of necessary repairs, please contact your specialist dealer.

Only the use of spare parts approved by the manufacturer or original spare parts is permitted. If unauthorized or non-original spare parts are used, the user is liable for consequential injury to persons or property resulting in the manufacturer being deprived of all liability.

1.4 SYMBOLS ON MACHINE

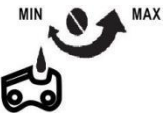
	<p>Wear an equipment of protection including a helmet, protective glasses, hearing protection.</p>
	<p>Wear protective gloves.</p>
	<p>Wear protective and non-skid shoes.</p>
	<p>Read the instruction manual.</p>

	WARNING - Danger of kickback.
	Caution! The tool can contact to a voluminous material. Loss of control and injuries can be created.
	Warning – Risk of projection.
	Do not use saw blades.
	Keep bystanders away at least 15m.
	Warning – Risk of electric shock. Always beware of the danger from overhead electric-power line, keep a safe distance at least 10m from the power line.
	Guarantee noise level.
	Warning! Cutting elements.
	Exhausting gas is dangerous. Do not inhale them.
	Do not smoke.
	Caution: the accessible surface maybe hot when using the tool.
	GASOLINE+OIL mixed 40:1 - Position: FUEL TANK CAP.
	Chain oil tank - Position: CHINA OILTANK COVER.
	Choke lever - Position: AIR CLEANER COVER.

	<p>If you turn the rod by screwdriver follow the arrow to the “MAX” position, the chain oil flow more, and if you turn to the “MIN” position, less. Position: Bottom of the TRANSMISSION.</p>
	<p>Fuel pump.</p>
	<p>Maximum rotational frequency of the spindle.</p>
	<p>Maximum rotational frequency of the spindle of grass trimmer.</p>

2. THE TOOL

2.1 Main unit

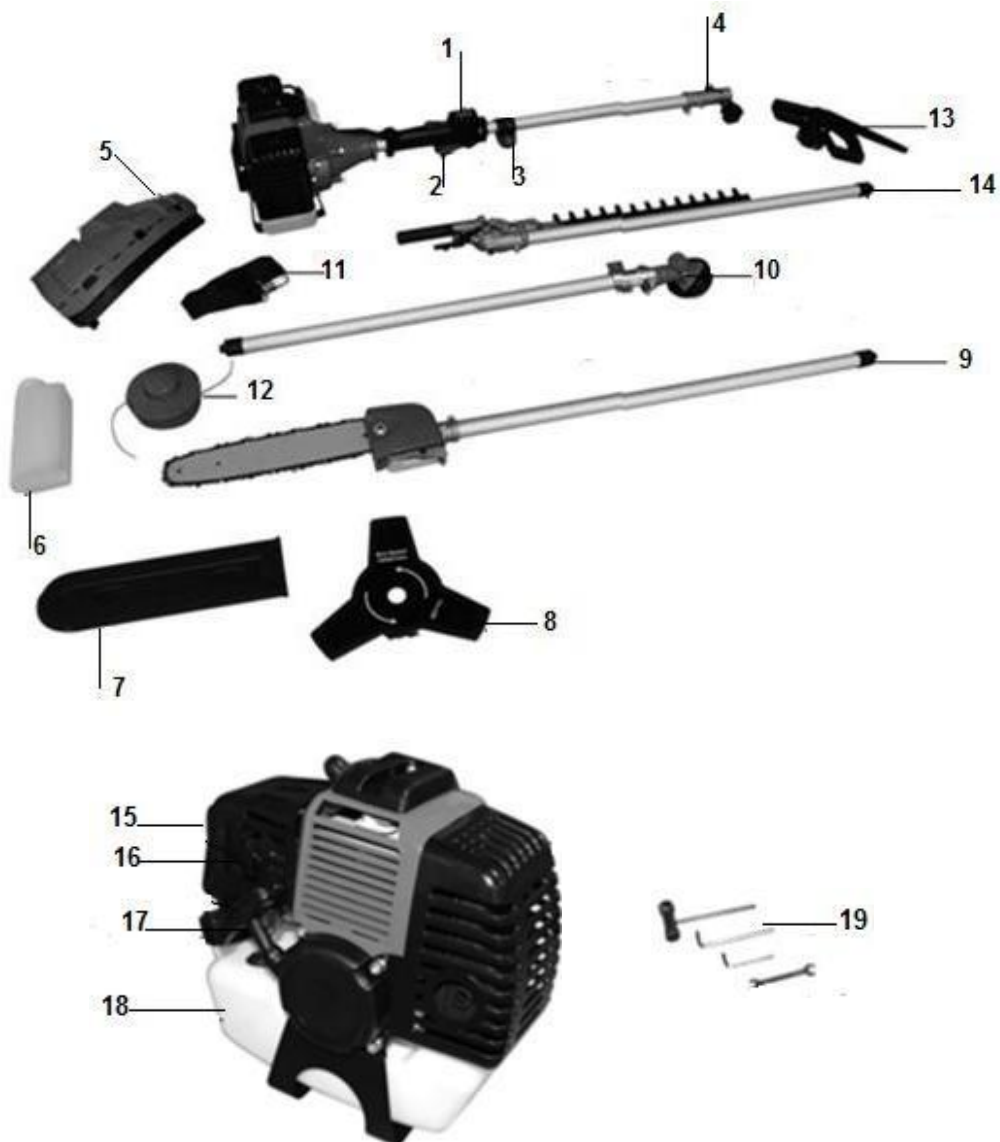

- | | |
|---|------------------------------------|
| 1. ON/OFF switch | 11. Shoulder strap |
| 2. Throttle lever | 12. Cutting head for grass trimmer |
| 3. Hanger | 13. Handle |
| 4. Mounting tube | 14. Hedge trimmer |
| 5. Carter of protection (brushcutter and trimmer) | 15. Air filter |
| 6. Bottle for the oil mixture | 16. Choke lever |
| 7. Cover protection of the blade (pruner) | 17. Starter |
| 8. 3 teeth blade (brush cutter) | 18. Fuel tank |
| 9. Pole mounted pruner | 19. Tool set |
| 10. Tube(brushcutter and trimmer) | |

2.2 Pole mounted pruner

- 1- Tube
- 2- Oil tank for lubrication
- 3- Saw chain



2.3 Hedge trimmer

- 1- Tube
- 2- Adjustment lever
- 3- Notching of adjustment 135° from cutting unit
- 4- Blade

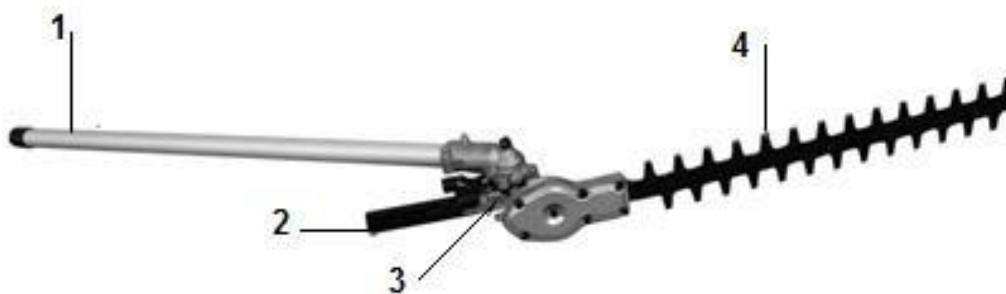

2.4 Brushcutter

- 1- Carter of protection
- 2- 3-teeth blade

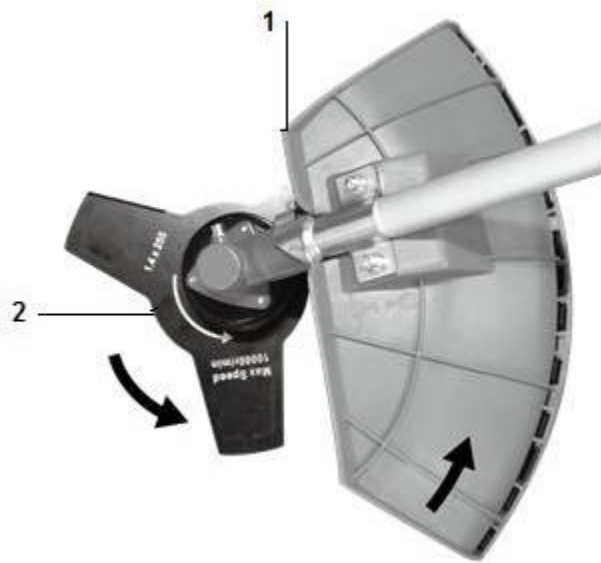

2.5 Grass trimmer

- 1- Nylon wire
- 2- Device of cutting the nylon wire
- 3- Carter of protection



3. ASSEMBLY

3.1 Handle

- Unscrew the handle.
- On the main unit, locate the two holes; Install the rubber tap by aligning the holes (the tap is inside the handle).
- Install first bottom of the handle, the pin must be inserted in the hole.
- Install then the last part of the handle and screw it with the four screws.
- Be sure that the handle is well oriented.

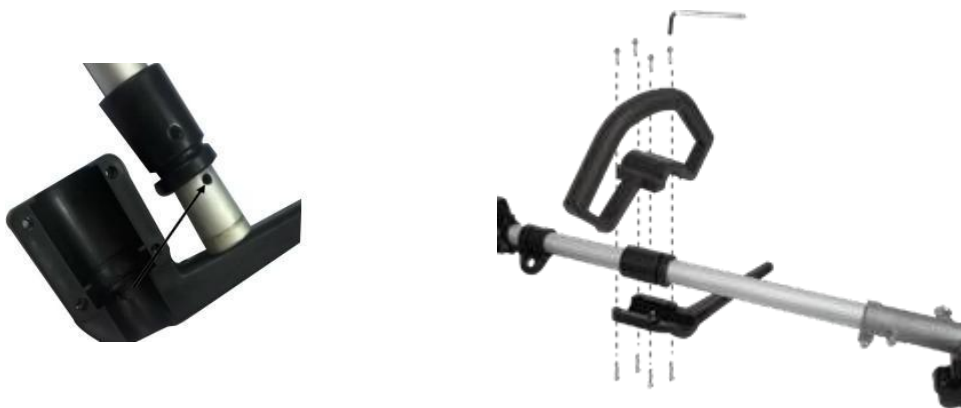

3.2 Tube on the main unit

- Remove the rubber which is on the end of the tube.
- On main unit, loosen the knob bolt if necessary. Pull out the pin and install the tube on the tool. Make sure that the pin is well inserted in the hole of the tube.
- Screw the knob bolt securely.

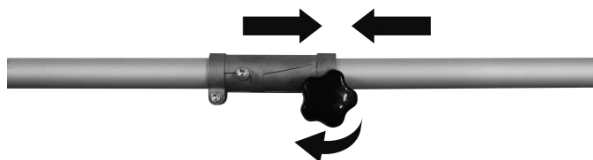

3.3 Carter of protection (Brush cutter and grass trimmer)

- Remove the two screws from the carter of protection.
- On the tube of the brushcutter/grass trimmer, place the carter of protection on its support.
- Screw the carter of protection with the two screws.

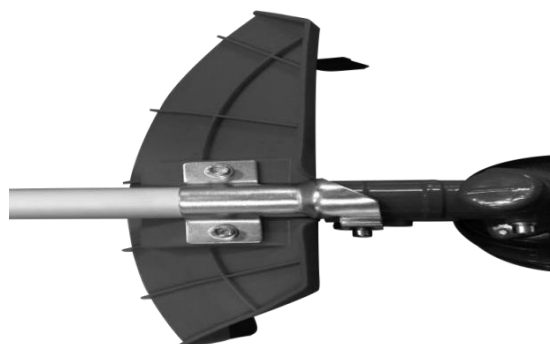

NOTE: when using the brushcutter or the grass trimmer, the carter of protection shall be always installed.

3.4 Blade for brushcutter

Warning - sharp edges; wear gloves when manipulate the blade

- On the tube of the brushcutter/grass trimmer, insert a metal locking tool into the hole on the side of the drive gear and on the tool drive.
- Remove cover bell and the holding nut from the shaft.
- Install, in the following order, on the shaft: the blade, the cover bell and then the holding nut.
- Remove the metal locking tool.
- Install the tube of the brushcutter to the main unit as explained above.



To remove the metal blade, put a metal locking tool into the hole on the side of the drive gear and on the tool drive. Unscrew the holding nut and then remove the cover bell and the blade.

NOTE:

After installation, always check if the installation is correct. If blade is not well installed, it will vibrate excessively and can cause injury. When operation, if there is abnormal vibration, immediately stop the tool and check the installation.

3.5 Cutting head for grass trimmer

- On the tube of the brushcutter/grass trimmer, insert a metal locking tool into the hole on the side of the drive gear and on the tool drive.
- Remove cover bell and the holding nut from the shaft.
- Install and screw the nylon cutting head. Make that it is well installed.
- Remove then the metal locking tool.
- Install the tube of the brushcutter to the main unit as explained above.
- To remove the nylon cutting head, put a metal locking tool into the tool and then unscrew the nylon cutting head.



3.6 Hedge trimmer

- There is no installation for the hedge trimmer; its tube can be directly installed on the main unit.

Adjusting of the working angle

NOTE: Always fit the blade cover

- Pull both locking ratchet and the locking pin to disengage them from their respective notches.
- Adjust the cutting head to desired working angle.
- Lock the ratchet and the locking pin.
- Ensure that they both firmly into position in their notches.

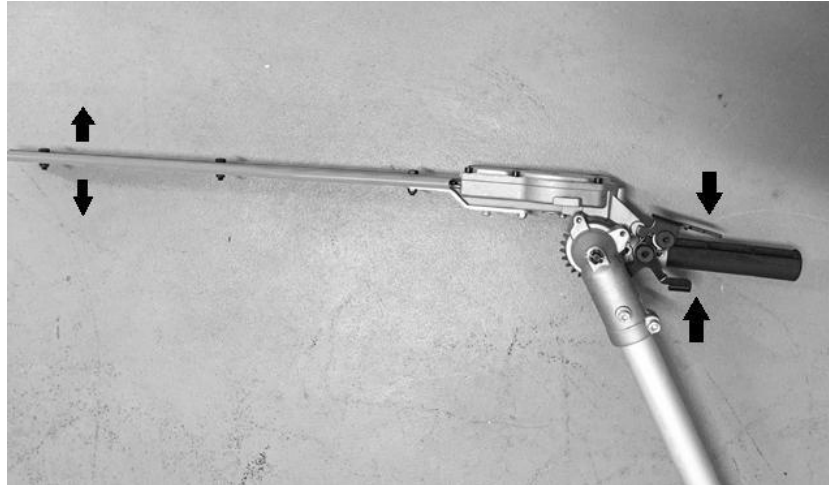

3.7 Pole pruner

Assembly of the chain guide and chain

- Remove the safety screw and remove the cover.



- Pass the chain on the chain guide. The chain must be in the direction as shown below. Make sure that the chain is well inserted in the groove of the chain guide.

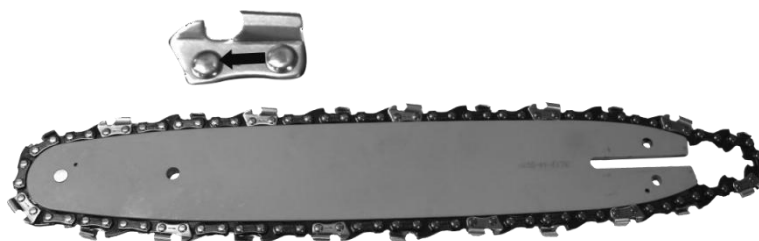

- Install the guide chain on the tool and pass the chain on the wheel chain.
- Install the cover and tighten the fastening screw.



Adjusting the chain tension

The chain must not have too much clearance, but it must be possible to lift the chain a few millimetres from the guide rail.

- Loosen the fixing screw.
- Slightly lift the end of the chain guide
- Check the cutting chain for ease of operation by turning it manually.
- Adjust the tension of the chain by means of the screw for adjusting the tension of the chain (4) so that the chain can be lifted a few millimetres from the center of the guide rail.
- Secure the safety screw.

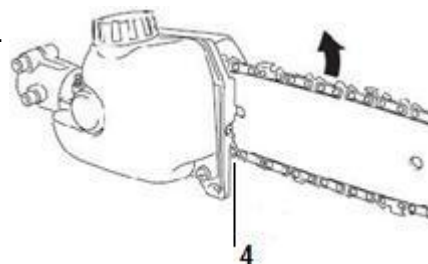

If the chain is not tight or not well installed, repeat the installation.

Filling oil tank

- Open the oil tank
- Pour a recommended lubrication oil (ask advice to your dealer). Do not overfill.
- Close the oil tank.

Checking the lubrication of the chain

- The machine must be sufficiently greased for it to function properly. Insufficient lubrication can shorten the life of the machine.
- If the lubrication is not sufficient, you shall fill the machine with lubricating oil.
- Before checking the oil, make sure that the guide and the chain are in place. Once the engine is started, turns it at medium speed and checks that the chain oil is sprayed and traces off the ground.

3.8 Installation of the harness

- Put on the harness.
- If necessary, adjust the bands of the harness to have the blade parallel to the ground when standing in your normal working position to provide you most effectiveness and comfort on operating the machine.
- Install the hook on the main unit to attach the harness.

Quick release mechanism

Pull the strip to release the machine from you in the case of emergency.



4. FILLING THE FUEL TANK

WARNING: When filling the tank:

The tool must always be stopped and cooled.

Never smoke during refueling. It must not have flames or sparks near the fuel.

Before refueling, allow the chainsaw to cool completely. Do not attempt to refuel when the engine is hot.

If fuel has been spilled, immediately stop refueling and do not start the engine. Clean up the spill and fill the machine in another location

Never fill the fuel tank to the flange; there is a risk of overflow. Do not refuel in a closed and unventilated area.

The fuel used for this tool is a mixture of unleaded gasoline and registered engine lubricant. When mixing gasoline with oil, use only gasoline that does not contain ethanol or methanol.

Unleaded gasoline is a quality gasoline type. This will help to avoid damaging the fuel lines of the engine and other engine parts.

Always use gasoline with a minimum octane rating of 90RON. Using gasoline with a lower octane rating may cause an increase in engine temperature, causing problems with the engine, including seizure.

The engine requires oil specially adapted for two-stroke engines with an air cooling system. Use quality oil enriched with corrosion-inhibiting products explicitly provided for two-stroke engines with an air cooling system (JASO FC or ISOEGC).

Do not use BIA or TCW OIL (suitable for 2-stroke engines equipped with a water cooling system).

The recommended mixing ratio is 40:1 (make sure the mixing ratio is correct before filling the product).

4.1 Mixing

- Mix in a clean, empty container (supplied).
- Pour the oil into the container.
- Pour the fuel into the tank. Mix the mixture long enough (more than one minute) to get a good combination.

4.2 Filling the fuel tank

- Unscrew the fuel tank cap and remove it.
- Fill the tank slowly with the mixture. Do not exceed the maximum capacity (fill to 80% of its capacity preferably).
- Replace the cap on the fuel tank and tighten it.
- Wipe any spillage around the unit if necessary.

Note: To avoid damage and accidents, DO NOT USE OTHER MIXTURES AND OTHER TYPES OF OIL / PETROL

4.3 Storage of fuel

The fuel must be kept in a clean and safe container and always closed.

If you are not using the product for a long time, remove the fuel mixture and add it to a container.

Do not leave the fuel for a long time in the product. The fuel may clog the carburetor and the engine will not operate properly.

4.4 Disposal of fuel

When the fuel is no longer used or worn, please dispose of it in an authorized location. Check local laws regarding disposal of fuels.

5. OPERATION

5.1 Starting the operation

■ Cold starting

- Switch on the tool by putting the Start/stop button on the position I (ON).
- Push the primer bulb 7-10 times, until fuel comes into the primer bulb.

- Pull the choke lever to the close position.  CLOSE

- Pull the starter cord until the engine starts.

- Pull the choke lever to the open position.  OPEN

- Allow engine to warm up for a few minutes before using.
- Push the safety switch then the throttle trigger to start the operation

■ Warm starting

The warm starting can be done when the tool was switched off but still hot.

- Switch on the tool by putting the Start/stop button on the position I (ON).
- Push the primer bulb 7-10 times, until fuel comes into the primer bulb.

- The choke lever must be kept in the open position.  OPEN . If it is not the case, restart the machine by performing a cold starting.

- Pull the starter cord until the engine starts.
- Allow engine to warm up for a few minutes before using.
- Push the safety switch then the throttle trigger to start the operation

5.2 Stopping the operation

- Release the throttle trigger.
- Let the tool to run a few minutes.
- Switch off the tool by putting the Start/stop switch on the position O (OFF).

5.3 Pole pruner operation

Never use the tool at an angle of more than 60 °. The correct operation of the pruner is not impaired at angles greater than 60 °, but the risk of injury increases due to sudden drops of branches. Pay attention to the floor in front of you when using the appliance. This allows you to avoid tripping over branches on the ground. Never use the saw without oil. Use a biodegradable chain oil. The pruning machine uses a low rebound chain. In addition, special attention has been paid to the construction of the device to prevent the smallest possible rebounds given the technical conditions given. Nevertheless, a slight rebound can not be ruled out by using the upper cutting blade. Expect a rebound when using this side of the blade or when the top of the blade comes into contact with another branch. The device should always be used with both hands. The thin branches can be cut at once. To prevent a branch from splitting or bending, it is advisable to slice it end to end. When slitting longer branches, the branch should be cut from the bottom. First cut the branch from below at a point away from where you want to saw the branch. The notch must have a depth between one third and one half the thickness of the branch. This prevents the branch from breaking when you cut it from the top a little further away from the trunk. To finish, saw the stump by making a straight cut. If you wish, you can seal the cut using a suitable product.

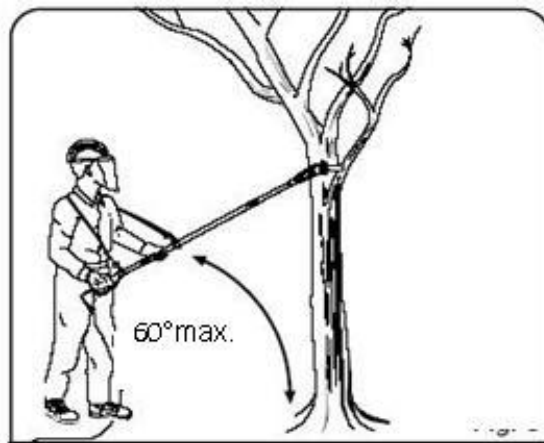

5.4 Grass trimmer operation

- Trimming

Tilt the head slowly to direct debris away from you. If cutting up to a barrier such as fence, wall or tree, approach from an angle where any debris ricocheting off the barrier will fly away from you. Move the line head slowly until the grass is cut right up the barrier, but do not jam (overfeed) the line into the barrier. If trimming up to a wire mesh or chain linked fence be careful to feed only up to wire. If you go too far the line will snap off around the wire. Trimming can be done to cut through weed stems one at a time. Place the trimmer line head near the bottom of the weed-never high up which could cause the weed to chatter and catch the line. Rather than cut the weed right through, just use the very end of the line to wear through the stem slowly.

- Scalping and edging

Both of these are done with the line head tilted at a steep angle. Scalping is removing top growth leaving the earth bare.

Edging is trimming the grass back where it has spread over a sidewalk or drive way. During both edging and scalping, hold the unit at a steep angle and in a position where the debris, and any dislodging dirt and stones, will not come back towards you even if it ricochets off the hard surface. Although the picture shows how to edge and scalp every operator must find for himself the angles which suits his body size and cutting situation.

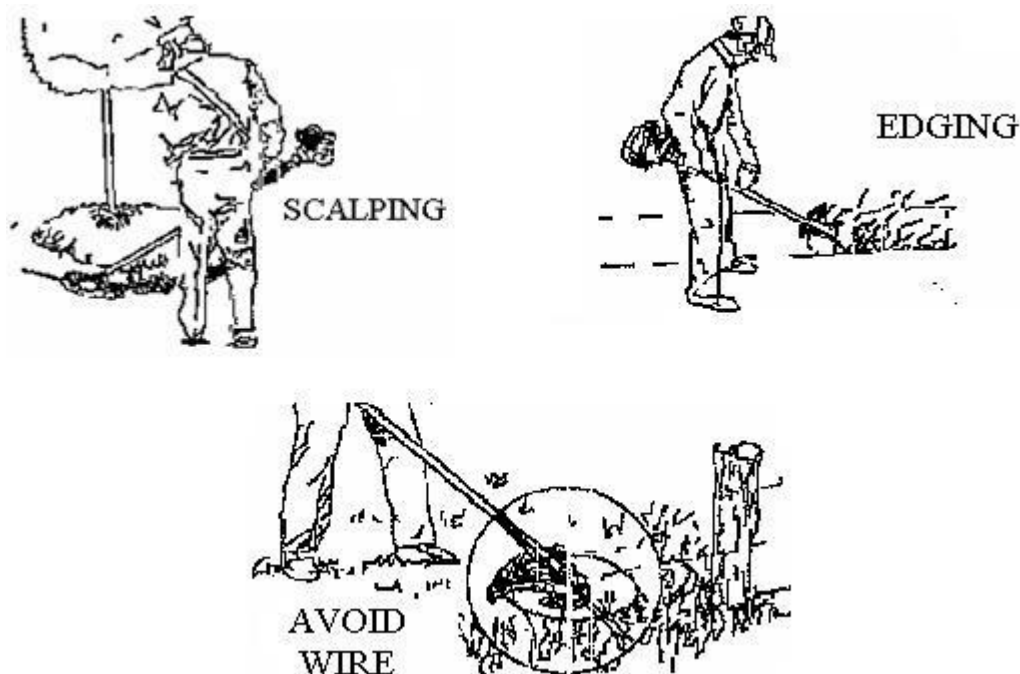

5.5 Brushcutter operation

- Do not use the brushcutter for cutting trees
- Do not cut with dull, cracked or damaged metal blade.
- Before cutting growth, inspect for obstructions such as boulders, metal stakes or strands of wire from broken fences. If an obstruction cannot be removed, mark its location so that you can avoid it with the blade. Rocks and metal will dull or damage a blade. Wire can catch on the blade head and flap around or be thrown into the air.
- Use the shoulder harness at all times adjust both harness and harness clamp on the unit so that the unit hangs a few inches above ground level. The cutting head and the debris shield should be level in all directions. Harness the unit on the right side of your body.
- Cut only with the side of the blade that the debris is moving away from you.
- If kickback occurs, the blade may be dull, or the material so thick and hard that you should use other tool instead of this machine.
- Do not force the blade to cut. Do not change the angle of cut after into the wood. Avoid using any pressure or leverage which could cause the blade to bind or crack.

Scything weeds

This is cutting by swinging the blade in a level arc. It can quickly clear areas of field grass and weeds. Scything should not be used to cut large, tough weeds or woody growths.

Scything can be done in both directions, or just in one way which results in the debris being thrown away

from you.

That is using the side of the blade that it is rotating away from you. Tilt down the blade slightly on this same side. You will be hit by some debris if you scythe in both directions.

5.6 Hedge trimmer operation

Warning! Never place the cutting head on the ground while the machine is running.

When using the machine on lawns, hold the scythe at an angle of 30°C and perform semicircular movements by sweeping the ground from left to right.

The best results are obtained when the grass is 15 cm high. When the grass is higher, we recommend repeating the mowing several times.

It is recommended to cut the trapezoidal hedges to prevent the lower branches from being stripped. This corresponds to the natural growth of plants and hedges can be potentially prosperous. The cut makes the new annual shoots reduced, so a dense branching and a good protection of the sight must be considered.

- First, cut the edges of a hedge. Move the hedge trimmer to cut the part that grows greatly from bottom to top. If you cut from top to bottom, the thinner branches move outward; Narrow places or holes may form.
- Cut the top of the hedge, just like a roof or a round shape.
- Cut the seedlings into the desired shape. The main stem must be intact and remain until the hedge reaches the proposed elevation. All other shoots should be cut to half.

6. CARE AND MAINTENANCE

Before any maintenance work, the machine must be switched off and completely cooled.

Maintenance shall be provided regularly and must be done according to the instructions provided in this instruction manual. A clean, well-maintained machine increases its lifetime and efficiency. Improper maintenance can cause damage, accidents and render the tool inoperable in the short term.

Any other maintenance, modification or repair must be carried out by a qualified professional. Do not immerse the tool in water or any other liquid.

6.1 Maintenance

a. Air filter

Check the air filter as often as necessary to maintain in a clean condition. Light surface dust can readily be removed by tapping the filter. Heavy deposits should be washed out in suitable solvent. To clean the filter, remove filter cover by loosening air filter cover knob.



b. Adjusting the carburetor

Do not adjust carburetor unless necessary. If you have trouble with the carburetor, see your dealer. Improper adjustment may cause engine damage and void warranty.

c. Fuel filter

Fuel tank is fitted with a filter. Filter is situated at the free end of fuel pipe. It can be picked with a hook or similar device. Check the fuel filter periodically. Do not allow dust to enter into fuel tank. Clogged filter will cause difficulty in starting engine or abnormalities in starting engine or abnormalities in engine performance.

When filter is dirty, replace the filter. When the inside of the fuel tank is dirty, it can be cleaned by rinsing the tank with gasoline.

d. Spark plug

The tool must be completely cold before manipulating the spark plug.

- Dévissez le couvercle puis enlevez le capuchon de la bougie d'allumage
- Clean or replace the spark plug in case of ozone contamination.
- Replace the spark plug if the end of the center electrode is worn.



e. Grass trimmer

Replacement of the cutting string

- Push the tab which is on the housing cutting string and turn the cover to open it (see the markings on the housing).
- Remove the string and replace it by a new one.
- To reinstall the cutting string, first pass the two ends of the string on the holes localized on the housing.
- Put the cutting string in the housing; pull correctly the string outside of the tool in equal part.
- Place the cover on the housing; turn it to lock it in place.

f. Hedge trimmer

Lubrication

Regularly lubricate the blade. Use a recommended grease to do it. Ask advice to your dealer about the recommended grease to use.

g. Pole pruner

Guide chain

Remove the chain guide. Clean the grooves and the oil inlet. Grease the pinion regularly.

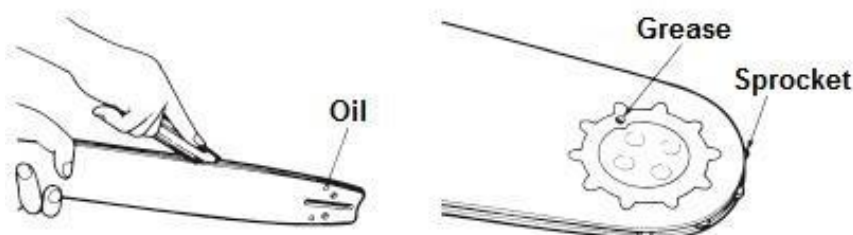

Verification

Turn the guide over regularly to avoid the effects of wear. The guide rail should keep the chain straight. The guide rail should always be in place. Use a ruler to examine it. If there is a gap between the guide and its rail, the rail is normal. Otherwise, the rail is worn. Once the rail is worn out, it must be corrected or replaced.

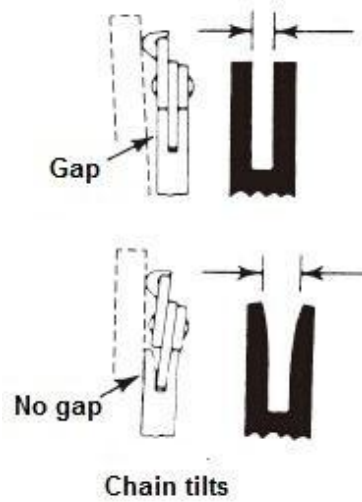

Sprocket

Examine the sprocket for signs of wear. If the wear is significant, replace it. Do not install a chain over a worn or damaged sprocket. Do not install a worn chain on a sprocket.

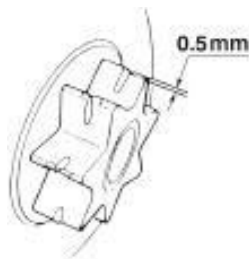

Chain

Each time, check that the cutter and the cutting angles match the diagram below.

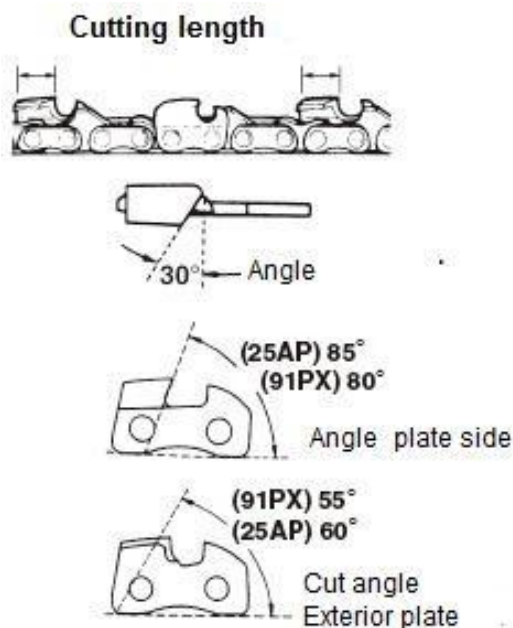

Chain sharpening

CAUTION: Wear protective gloves while sharpening the chain.

For optimum performance, we strongly recommend that you sharpen the chain regularly.

You can hire a professional to sharpen the chain, or you can do it yourself if you have enough experience and the right tools.

The chain must be sharpened when:

- The wood chips turn to powder
- You must force the tool to perform a normal cut
- The cut is not straight
- The vibrations increase
- Fuel consumption has increased

Sharpening method

The chainsaw should be turned off and locked before sharpening. Use a file or a round sharpening device (ask your dealer for advice).

Place the file on the tooth and push forward. Go on to the next tooth by continuing this movement. After you have sharpened all the teeth, check that they are sharp.

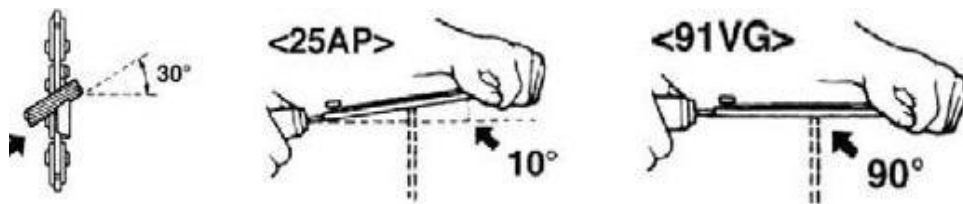

6.2 Storage

- Inspect and clean the tool as explained in this manual.
- Empty fuel tank (it can be done by switching on the tool and let it consume all remaining fuel).
- Disassemble the accessories.
- Store the main unit and the accessories in a clean area, out of reach of children. It is recommended to place the tool and accessories in the original package.

7. TECHNICAL DATA

Engine information	
Type of engine	RY1E44-5, 2-stroke engine
Volume of the fuel tank	1200 cm ³
Max engine speed	Max. 10000 min ⁻¹
Engine idling speed	3200±300 min ⁻¹
Clutch engagement speed	Min. 4500 min ⁻¹
Engine displacement	52 cm ³
Maximal power	1,4 kW
Carburettor	MZ15A/Stable, MR15A2- 43A/HLIC, 12S21/Huayi, WYK445/Walbro

Spark plug	BOSCH L8RTF, NHSP LD L8RTF, TORCH L7RTC, NGK BP MR7A
Guarantee sound power level	117 dB(A)
Brushcutter	
Unit without cutting attachment, empty tank	7,3 kg
Cutting diameter	255 mm
Cutting thickness	1.4 mm
Number of cutting teeth	Three teeth metal blade
Blade hole centre diameter	25.4 cm
Maximum rotational frequency of the spindle	7500 min ⁻¹
Gear ratio	4:3
Engine speed with cutting attachment	10000 min ⁻¹
Cutting blade	ROYAL GARDEN 10000/min
Vibration ahv (front handle) Vibration ahv (rear handle)	a _{hveq} =5.81m/s ² ,K=1.5m/s ² a _{hveq} =8.16m/s ² ,K=1.5m/s ²
Noise Emission	Sound pressure: L _{pA} , a _v = 97,6dB(A) ,K=3dB(A) Sound power: L _{wA} , a _v = 114dB(A) ,K=3dB(A)
Hedge trimmer	
Unit without cutting attachment, empty tank	7.9 kg
Cutting length	390mm (PN410/Royal Garden), 425mm (YK-58/YINKE)
Type of the hedge trimmer blade	PN410/Royal Garden, YK-58/YINKE
Engine speed with hedge trimmer attachment	10000 min ⁻¹
Gear ratio	28:7(PN410), 43:7(YK-58)
Vibration ahv (front handle) Vibration ahv (rear handle)	10m/s ² ,K=1.5m/s ²
Noise Emission	Sound pressure: L _{pA} , a _v =93dB(A), K=3dB(A) Sound power: L _{wA} , a _v = 113dB(A) ,K=3dB(A)
Grass trimmer	
Unit without cutting attachment, empty tank	7.3 kg
Cutting diameter	420 mm
Cutting thickness	Ø2,5/2mm
Number of cutting teeth	2 lines (non-metallic flexible line)
Maximum rotational frequency of the spindle	6600/min
Gear ratio	4:3
Cutting string head	ROYAL, 10000/min
Engine speed with cutting attachment	9000 min ⁻¹
Vibration ahv (front handle) Vibration ahv (rear handle)	a _{hveq} =5.83m/s ² ,K=1.5m/s ² a _{hveq} =8.14m/s ² ,K=1.5m/s ²

Noise Emission	Sound pressure: LpA,av= 97,6dB(A) ,K=3dB(A) Sound power: LwA, av = 114dB(A) ,K=3dB(A)
Pole pruner	
Unit without cutting attachment, empty tank	7.5 kg
Volume of oil tank	140 cm ³
Cutting length	300/260 mm
Chain pitch	9,525 mm
Chain gauge	1,27 mm
Sprocket	7 Teeth x 9,525mm
Chain type	91P045X/Oregon, N1C-BL-44E/Carlton, 91P040X/Oregon, 3/8.050-39/Kangxin, 3/8LP 44/Kangxin
Type of the chain guide bar	AL12-44-507P/Kangxin, 120SDEA318/Oregon, 100SDEA318/Oregon, AL10-39-507P/Kangxin, AL12-44-507P/Kangxin
Gear ratio	1:1
Engine speed with cutting attachment	9300min ⁻¹
Vibration ahv (front handle) Vibration ahv (rear handle)	ahveq=5,84m/s ² ,K=1.5m/s ² ahveq=8,16m/s ² ,K=1.5m/s ²
Noise Emission	Sound pressure: LpA, av = 96,2dB(A), K=3dB(A) Sound power: LwA, av = 109,6 dB(A), K=3dB(A)

8. TROUBLESHOOTING

Problems	Causes	Resolutions
The tool cannot be started	The starting process is not followed	Follow the instructions of use of this manual
	Spark plug dirty or moist	Clean the spark plug or replace it by a new one
	Incorrect carburetor adjustment	Contact your dealer or contact SWAP
The tool starts but no in a full power	Non correct setting of the starter	Open the starter
	Air filter is dirty	Clean the air filter
	Incorrect carburetor adjustment	Contact your dealer or contact SWAP
The engine cannot reach its maximal power	Non correct gap between the electrode and the spark plug	Clean the spark plug and adjust the gap between the electrodes or replace them
	Incorrect carburetor adjustment	Contact your dealer or contact SWAP
The engine generate of lot of smoke	Incorrect mix of the tank	Do a correct mix of the fuel (see the corresponding chapter)
	Incorrect carburetor adjustment	Contact your dealer or contact SWAP

9. DECLARATION OF CONFORMITY EC



BUILDER SAS
ZI, 32 rue Aristide Bergès – 31270 Cugnaux - France

Declare that the tool:
Gasoline multi tool kit Ref:
HCOMBI55-1

Serial number: 20211242072-20211242521

Is in conformity with the Directive Machine 2006/42/EC and the national regulation transposing it

Also in conformity with the following European regulation:
EMC Directive 2014/30/EU
Emission Directive 2016/1628/EU
Directive 1907/2006/EU (REACH)

Noise Directive 2000/14/EC Annex V + 2005/88/EC

Guarantee sound power level	117 dB(A)
Brushcutter	Sound power: LwA, = 114dB(A) ,K=3dB(A)
Hedge trimmer	Sound power: LwA, = 113dB(A) ,K=3dB(A)
Grass trimmer	Sound power: LwA, = 114dB(A) ,K=3dB(A)
Pole pruner	Sound power: LwA, = 113dB(A),K=3dB(A)

Is also in conformity with the following standards:
EN ISO 11806-1:2011
EN ISO 15017:2019
EN ISO 11680-1:2011
EN ISO 14982:2009

Responsible of the technical file: Mr. Olivier Patriarca

Cugnaux, 22/11/2021

Philippe MARIE

10. WARRANTY

HYUNDAI

WARRANTY

The manufacturer guarantees the product against defects in material and workmanship for a period of 2 years from the date of the original purchase. The warranty only applies if the product is for household use. The warranty does not cover breakdowns due to normal wear and tear.

The manufacturer agrees to replace parts identified as defective by the designated distributor. The manufacturer does not accept responsibility for the replacement of the machine, in whole or in part, and/or ensuing damage.

The warranty does not cover breakdowns due to:

- insufficient maintenance.
- abnormal assembly, adjustment or operations of the product.
- parts subject to normal wear and tear.

The warranty does not extend to:

- shipping and packaging costs.
- using the tool for a purpose other than that for which it was designed.
- the use and maintenance of the machine done in a manner not described in the user manual.

Due to our policy of continuous product improvement, we reserve the right to alter or change specifications without notice. Consequently, the product may be different from the information contained therein, but a modification will be undertaken without notice if it is recognized as an improvement of the preceding characteristic.

READ THE MANUAL CAREFULLY BEFORE USING THE MACHINE.

When ordering spare parts, please indicate the part number or code, you can find this in the spare parts list in this manual. Keep the purchase receipt; without it, the warranty is invalid. To help you with your product, we invite you to contact us by phone or via our website:

- **+33 (0)9.70.75.30.30**
- **<https://services.swap-europe.com/contact>**

You must create a "ticket" via the web platform.

- Register or create your account.
- Indicate the reference of the tool.
- Choose the subject of your request.
- Describe your problem.
- Attach these files: invoice or sales receipt, photo of the identification plate (serial number), photo of the part you need (for example: pins on the transformer plug which are broken).



11. PRODUCT FAILURE

WHAT TO DO IF MY MACHINE BREAKS DOWN?

If you bought your product in a store:

- a) Empty the fuel tank if your product has one.
- b) Make sure that your machine is complete with all accessories supplied, and clean! If this is not the case, the repairer will refuse the machine.

Go to the store with the complete machine and with the receipt or invoice.

If you bought your product on a website:

- a) Empty the fuel tank if your product has one..
- b) Make sure that your machine is complete with all accessories supplied, and clean! If this is not the case, the repairer will refuse the machine.
- c) Create a SWAP-Europe service ticket on the site: <https://services.swap-europe.com> When making the request on SWAP-Europe, you must attach the invoice and the photo of the nameplate (serial number).
- d) Contact the repair station to make sure it is available before dropping off the machine.

Go to the repair station with the complete machine packed, accompanied by the purchase invoice and the station support sheet downloadable after the service request is completed on the SWAP-Europe site

For machines with engine failure from manufacturers BRIGGS & STRATTON, HONDA and RATO, please refer to the following instructions.

Repairs will be done by approved engine manufacturers of these manufacturers, see their site:

- <http://www.briggsandstratton.com/eu/fr>
- <http://www.honda-engines-eu.com/fr/service-network-page;jsessionid=5EE8456CF39CD572AA2AEEDFD290CDAE>
- <https://www.rato-europe.com/it/service-network>

Please keep your original packaging to allow for after-sales service returns or pack your machine with a similar cardboard box of the same dimensions.

For any question concerning our after-sales service you can make a request on our website <https://services.swap-europe.com>

Our hotline remains available at +33 (9) 70 75 30 30.



12. WARRANTY EXCLUSIONS

THE WARRANTY DOES NOT COVER:

- Start-up and setting up of the product.
- Damage resulting from normal wear and tear of the product.
- Damage resulting from improper use of the product.
- Damage resulting from assembly or start-up not in accordance with the user manual.
- Breakdowns related to carburetion beyond 90 days and fouling of carburetors.
- Periodic and standard maintenance events.
- Actions of modification and dismantling that directly void the warranty.
- Products whose original authentication marking (brand, serial number) has been degraded, altered or withdrawn.
- Replacement of consumables.
- The use of non-original parts.
- Breakage of parts following impacts or projections.
- Accessories breakdowns.
- Defects and their consequences linked to any external cause.
- Loss of components and loss due to insufficient screwing.
- Cutting components and any damage related to the loosening of parts.
- Overload or overheating.
- Poor power supply quality: faulty voltage, voltage error, etc.
- Damages resulting from the deprivation of enjoyment of the product during the time necessary for repairs and more generally the costs related to the immobilization of the product.
- The costs of a second opinion established by a third party following an estimate by a SWAP-Europe repair station
- The use of a product which would show a defect or a breakage which was not the subject of an immediate report and/or repair with the services of SWAP-Europe.
- Deterioration linked to transport and storage*.
- Launchers beyond 90 days.
- Oil, petrol, grease.
- Damages related to the use of non-compliant fuels or lubricants.

* In accordance with transport legislation, damage related to transport must be declared to carriers within 48 hours maximum after observation by registered letter with acknowledgement of receipt.

This document is a supplement to your notice, a non-exhaustive list.

Attention: all orders must be checked in the presence of the delivery person. In case of refusal by the delivery person, it you must simply refuse the delivery and notify your refusal.

Reminder: the reserves do not exclude the notification by registered letter with acknowledgement within 72 hours.

Information: Thermal devices must be wintered each season (service available on the SWAP-Europe site). Batteries must be charged before being stored.

HYUNDAI
POWER PRODUCTS

For Inquiries, please contact:

BUILDER SAS
32, Rue Aristide Bergès Z1 31270 Cugnaux, France
Tél.: +33(0)5.34.502.502 Fax : +33(0)5.34.502.503
<http://www.hyundaipower-fr.com/>
Fabriqué en République Populaire de Chine(PRC)